



MUR1520  
MURB1520  
MURB1520-1

Ultrafast Rectifier

Features

- Ultrafast Recovery Time
- Low Forward Voltage Drop
- Low Leakage Current
- 175°C Operating Junction Temperature

$t_{rr} = 35ns$
$I_{F(AV)} = 15Amp$
$V_R = 200V$

Description/ Applications

International Rectifier's MUR.. series are the state of the art Ultra fast recovery rectifiers specifically designed with optimized performance of forward voltage drop and ultra fast recovery time.





The planar structure and the platinum doped life time control, guarantee the best overall performance, ruggedness and reliability characteristics.

These devices are intended for use in the output rectification stage of SMPS, UPS, DC-DC converters as well as free-wheeling diode in low voltage inverters and chopper motor drives.

Their extremely optimized stored charge and low recovery current minimize the switching losses and reduce over dissipation in the switching element and snubbers.

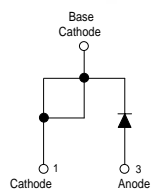
Absolute Maximum Ratings

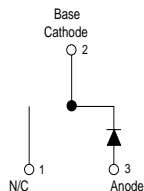
Parameters	Max	Units
$V_{RRM}$ Peak Repetitive Peak Reverse Voltage	200	V
$I_{F(AV)}$ Average Rectified Forward Current Total Device, (Rated $V_R$ ), $T_C = 150^\circ C$	15	A
$I_{FSM}$ Non Repetitive Peak Surge Current	200	
$I_{FM}$ Peak Repetitive Forward Current (Rated $V_R$ , Square wave, 20 KHz), $T_C = 150^\circ C$	30	
$T_J, T_{STG}$ Operating Junction and Storage Temperatures	-65 to 175	$^\circ C$

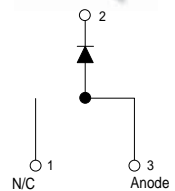
Case Styles		
<p>MUR1520</p>   <p>TO-220AC</p>	<p>MURB1520</p>   <p>D<sup>2</sup>PAK</p>	<p>MUR1520-1</p>   <p>TO-262</p>

**Electrical Characteristics @ T<sub>J</sub> = 25°C (unless otherwise specified)**

Parameters	Min	Typ	Max	Units	Test Conditions
V <sub>BR</sub> , V <sub>r</sub> Breakdown Voltage, Blocking Voltage	200	-	-	V	I <sub>R</sub> = 100μA
V <sub>F</sub> Forward Voltage	-	-	1.05	V	I <sub>F</sub> = 15A
	-	-	0.85	V	I <sub>F</sub> = 15A, T <sub>J</sub> = 150°C
I <sub>R</sub> Reverse Leakage Current	-	-	10	μA	V <sub>R</sub> = V <sub>R</sub> Rated
	-	-	500	μA	T <sub>J</sub> = 150°C, V <sub>R</sub> = V <sub>R</sub> Rated
C <sub>T</sub> Junction Capacitance	-	55	-	pF	V <sub>R</sub> = 200V
L <sub>S</sub> Series Inductance	-	8.0	-	nH	Measured lead to lead 5mm from package body

**Dynamic Recovery Characteristics @ T<sub>J</sub> = 25°C (unless otherwise specified)**

Parameters	Min	Typ	Max	Units	Test Conditions
t <sub>rr</sub> Reverse Recovery Time	-	-	35	ns	I <sub>F</sub> = 1.0A, di <sub>F</sub> /dt = 50A/μs, V <sub>R</sub> = 30V
	-	22	-		T <sub>J</sub> = 25°C
	-	39	-		T <sub>J</sub> = 125°C
I <sub>RRM</sub> Peak Recovery Current	-	1.6	-	A	T <sub>J</sub> = 25°C
	-	4.1	-		T <sub>J</sub> = 125°C
Q <sub>rr</sub> Reverse Recovery Charge	-	19	-	nC	T <sub>J</sub> = 25°C
	-	90	-		T <sub>J</sub> = 125°C

I<sub>F</sub> = 15A  
V<sub>R</sub> = 160V  
di<sub>F</sub>/dt = 200A/μs

**Thermal - Mechanical Characteristics**

Parameters	Min	Typ	Max	Units
T <sub>J</sub> Max. Junction Temperature Range	- 65	-	175	°C
T <sub>Stg</sub> Max. Storage Temperature Range	- 65	-	175	
R <sub>thJC</sub> Thermal Resistance, Junction to Case	-	-	1.5	°C/ W
R <sub>thJA</sub> Thermal Resistance, Junction to Ambient	-	-	50	
R <sub>thCS</sub> <sup>①</sup> Thermal Resistance, Case to Heatsink	-	0.5	-	
Wt Weight	-	2.0	-	g
	-	0.07	-	(oz)
Mounting Torque	6.0	-	12	Kg-cm
	5.0	-	10	lbf.in

① Mounting Surface, Flat, Smooth and Greased

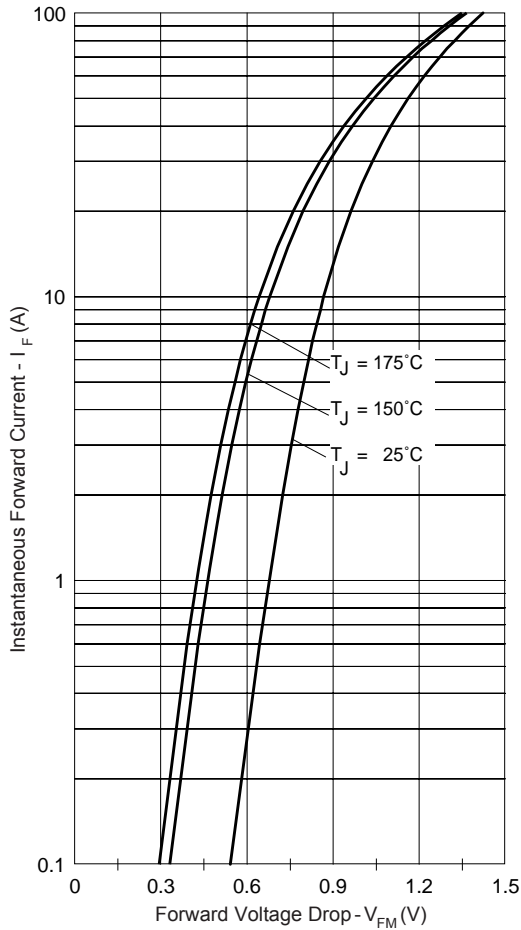

Fig. 1 - Typical Forward Voltage Drop Characteristics

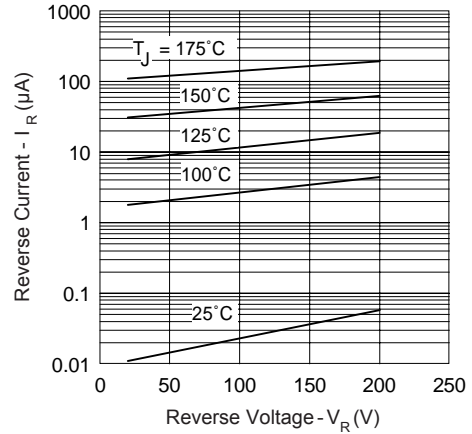

Fig. 2 - Typical Values Of Reverse Current Vs. Reverse Voltage

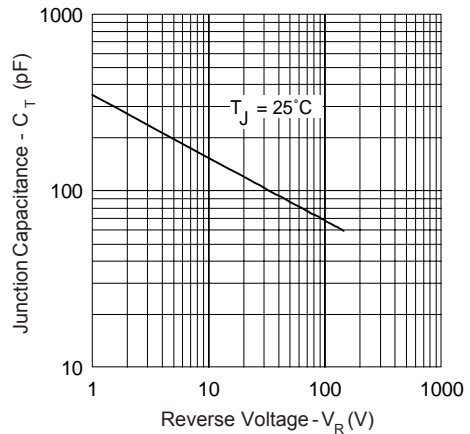

Fig. 3 - Typical Junction Capacitance Vs. Reverse Voltage

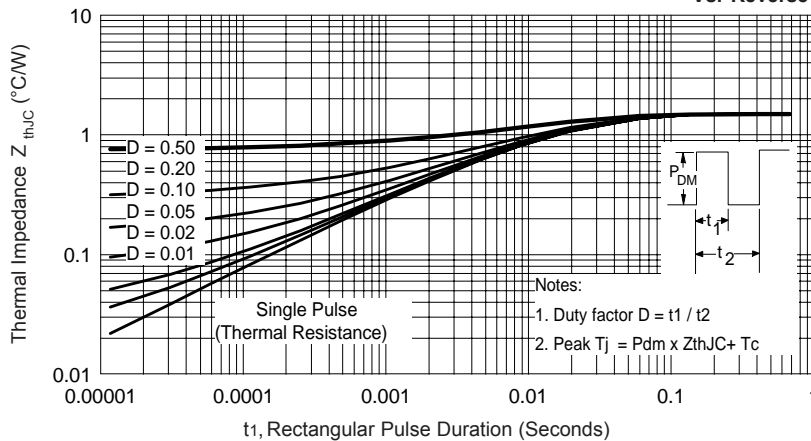

Fig. 4 - Max. Thermal Impedance  $Z_{thJC}$  Characteristics

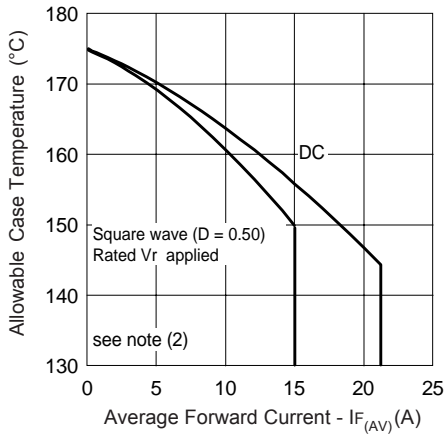

Fig. 5 - Max. Allowable Case Temperature Vs. Average Forward Current

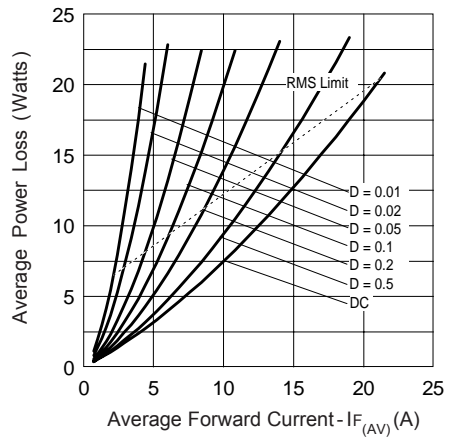

Fig. 6 - Forward Power Loss Characteristics

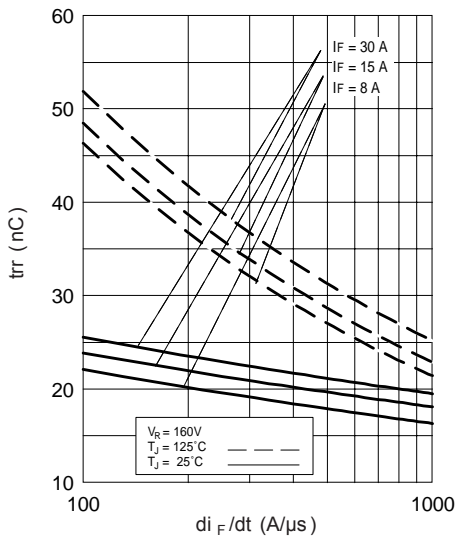

Fig. 7 - Typical Reverse Recovery vs.  $di_F/dt$

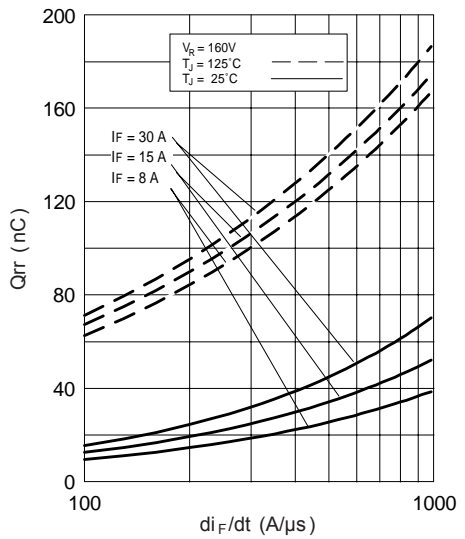
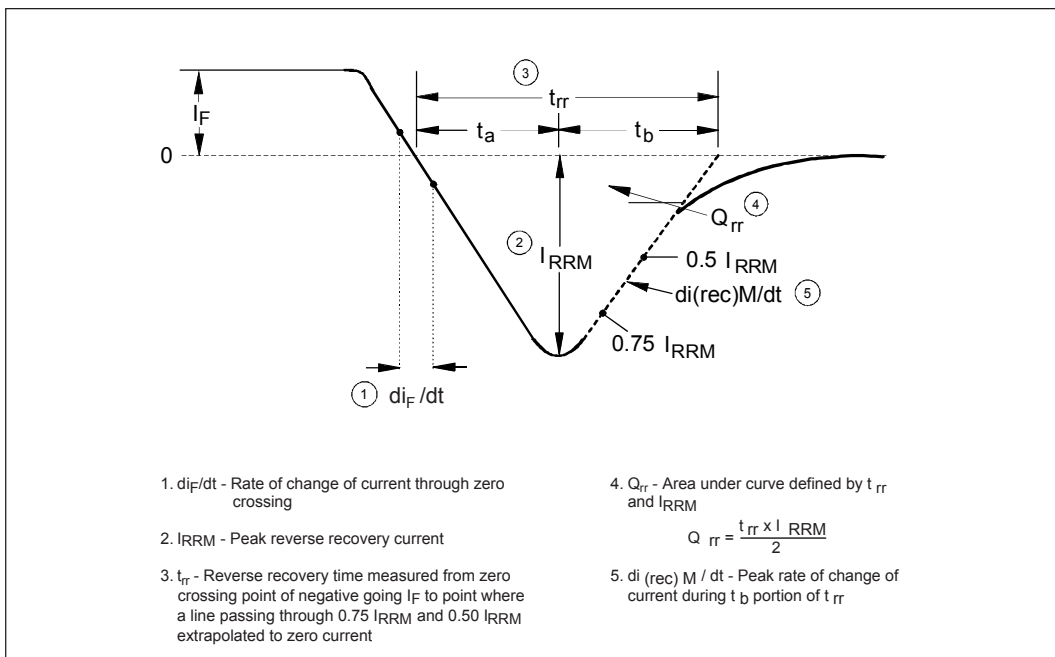
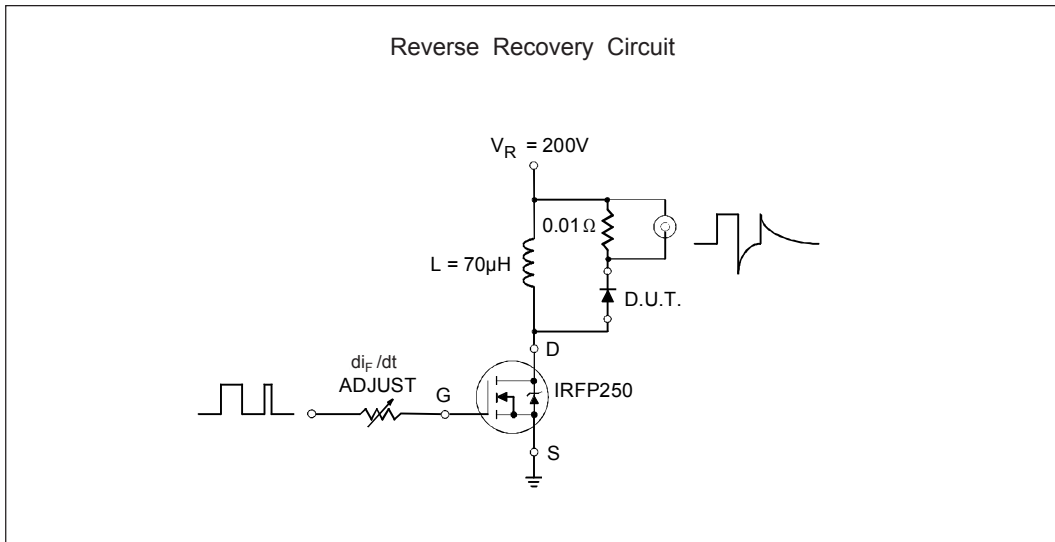

Fig. 8 - Typical Stored Charge vs.  $di_F/dt$

(2) Formula used:  $T_C = T_J - (Pd + Pd_{REV}) \times R_{thJC}$ ;

$Pd$  = Forward Power Loss =  $I_{F(AV)} \times V_{FM} @ (I_{F(AV)}/D)$  (see Fig. 6);

$Pd_{REV}$  = Inverse Power Loss =  $V_{R1} \times I_R (1 - D)$ ;  $I_R @ V_{R1} = \text{rated } V_R$



Outline Table

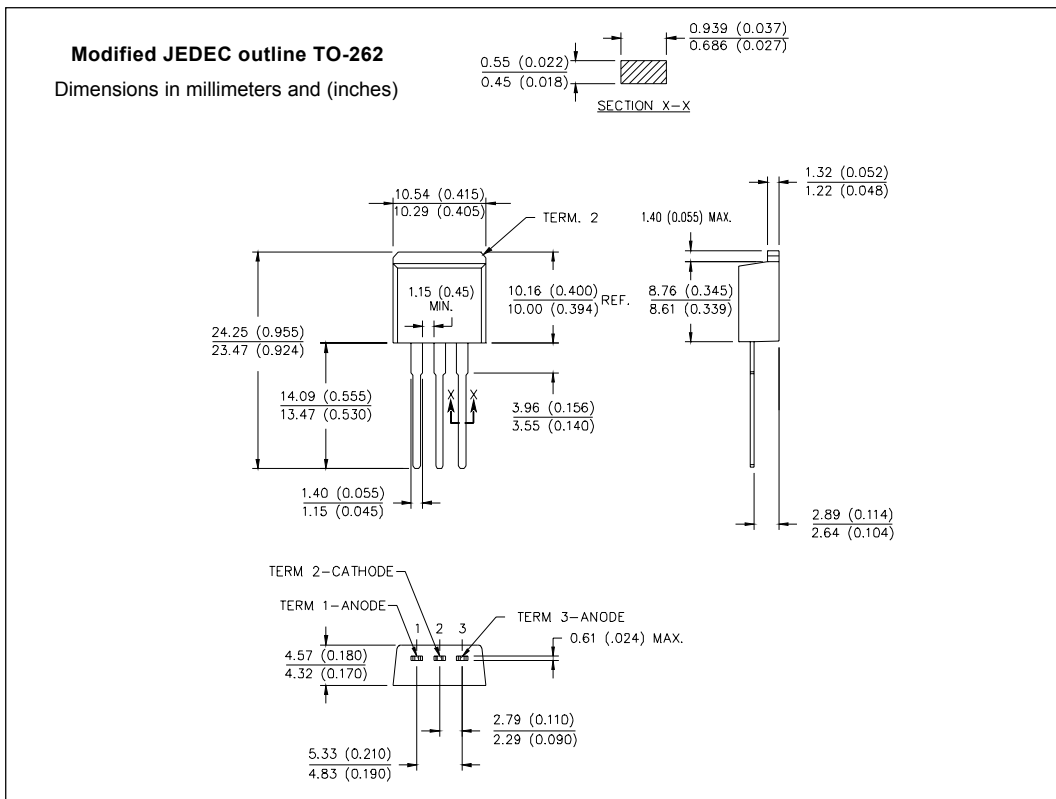
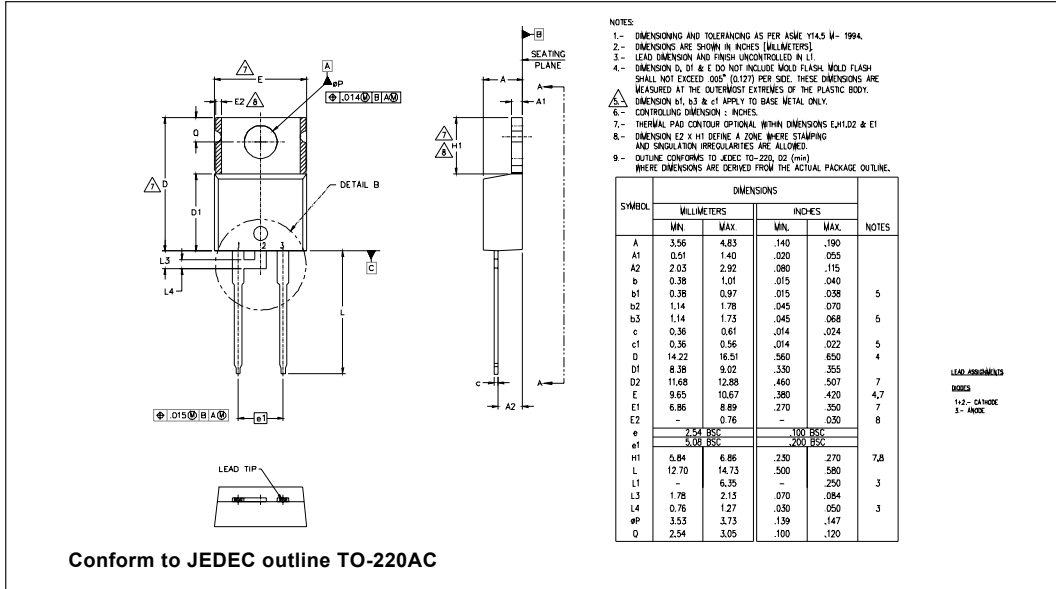

Outline Table

NOTES:  
 1. DIMENSIONING AND TOLERANCING PER ASME Y14.5M-1994  
 2. DIMENSIONS ARE SHOWN IN MILLIMETERS [INCHES]  
 3. DIMENSION D & E DO NOT INCLUDE MOLD FLASH. MOLD FLASH SHALL NOT EXCEED 0.127 [0.005"] PER SIDE. THESE DIMENSIONS ARE MEASURED AT THE OUTMOST EXTREMES OF THE PLASTIC BODY.  
 4. DIMENSION b1 AND c1 APPLY TO BASE METAL ONLY.  
 5. CONTROLLING DIMENSION: INCH.

SYMBOL	DIMENSIONS				NOTES
	MILLIMETERS		INCHES		
A	4.06	4.83	.160	.190	4
A1	0.00	0.254	.000	.010	
b	0.51	0.99	.020	.039	
b1	0.51	0.89	.020	.035	
b2	1.14	1.78	.045	.070	
c	0.38	0.74	.015	.029	
c1	0.38	0.58	.015	.023	
e2	1.14	1.65	.045	.065	
D	8.51	9.65	.335	.380	
D1	6.86		.270		
E	9.65	10.67	.380	.420	3
E1	6.22		.245		
e	2.54 BSC		.100 BSC		IGBTs, CO-PACK
H	14.61	15.88	.575	.625	
L	1.78	2.79	.070	.110	
L1		1.65	.065		
L2	1.27	1.78	.050	.070	LEAD ASSIGNMENTS
L3	0.25 BSC		.010 BSC		
L4	4.78	5.28	.188	.208	
m	17.78		.700		HEXMET
m1	8.89		.350		
n	11.43		.450		1.- GATE 2, 4.- BRN 3.- SOURCE
o	2.08		.082		
p	3.81		.150		
R	0.51	0.71	.020	.028	1.- ANODE + 2, 4.- CATHODE 3.- ANODE
ø	90°	93°	90°	93°	

HEXMET  
 1.- GATE  
 2, 4.- BRN  
 3.- SOURCE

IGBTs, CO-PACK  
 1.- GATE  
 2, 4.- BRN  
 3.- ANODE

DIGIDES  
 1.- ANODE +  
 2, 4.- CATHODE  
 3.- ANODE

\* PART DEPENDENT.

Conform to JEDEC outline D<sup>2</sup>Pak (SMD-220)

Ordering Information Table

Device Code

MUR	B	15	20	CT	-1	-
1	2	3	4	5	6	7

- 1** - Ultrafast MUR Series
- 2** - B = D<sup>2</sup>Pak/ TO-262  
None = TO-220AC
- 3** - Current Rating (15 = 15A)
- 4** - Voltage Rating (20 = 200V)
- 5** - CT = Center Tap (Dual) TO-220 /D<sup>2</sup>PAK/ TO-262
- 6** - "-1" = TO-262 Option
- 7** - • none = Standard Production  
• PbF = Lead-Free

```

MUR1520
*****
* SPICE Model Diode *
*****
.SUBCKT MUR1520 ANO CAT
D1 ANO 1 CAT
*Define diode model
.MODEL DMOD D Is=16.9E-09 N=1.332 Rs=4.439E-03 Ikf=.232 Xti=2 Eg=1.11
                Cjo=700.3E-09 M=.3715 Vj=.1784 Fc=.5 Isr=1.389E-09
                Nr=3.002 Bv=270 Ibv=95.79E-6 Tt=10.49E-9)

*****

.ENDS MUR1520

Thermal Model Subcircuit
.SUBCKT MUR1520 5 1

CTHERM1  5  4  2.23E+01
CTHERM2  4  3  1.23E+02
CTHERM3  3  2  3.35E+02
CTHERM4  2  1  4.75E+02

R THERM1  5  4  7.55E-01
R THERM2  4  3  5.90E-02
R THERM1  3  2  1.01E-01
R THERM1  2  1  5.43E-02

.ENDS MUR1520
    
```

Data and specifications subject to change without notice.  
 This product has been designed and qualified for Industrial Level.  
 Qualification Standards can be found on IR's Web site.